

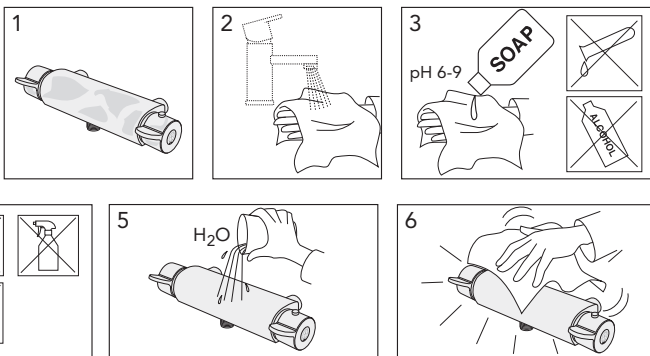

Skötsel
Maintenance
Beskyttelse
Vedlikehold
Hoito-ohje
Уход
Hooldus
Kopšanas informācija
Montavimas
Догляд
Péče o baterii
Starostlivosť o batériu

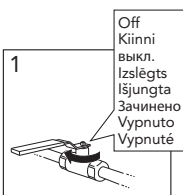

150 c-c

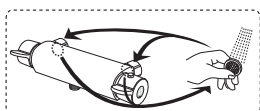

Off
Kiinni
выкл.
Izslēgts
Išjungta
Зачинено
Vurputo
Vurputé



160 c-c

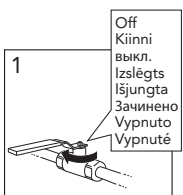
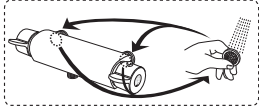

Off
Kiinni
выкл.
Izslēgts
Išjungta
Зачинено
Vurputo
Vurputé

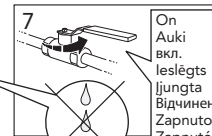
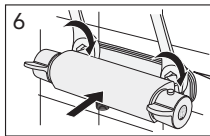
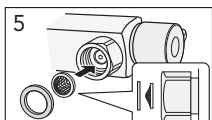
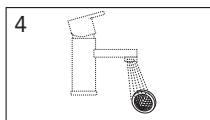
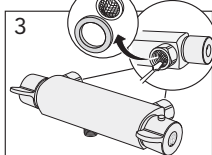
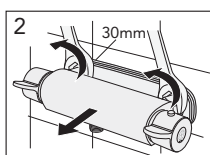

On
Auki
вкл.
Ieslēgts
Ijungta
Відчинено
Zapnuto
Zapnuté

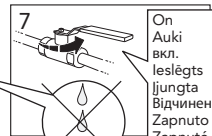
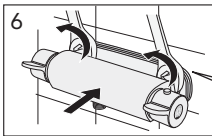
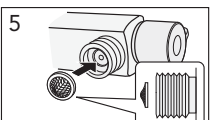
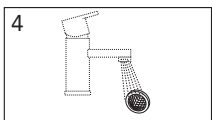
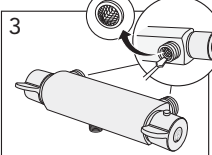
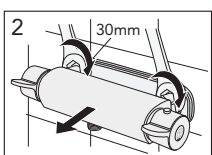

On
Auki
вкл.
Ieslēgts
Ijungta
Відчинено
Zapnuto
Zapnuté



A MEMBER OF THE
VILLEROY & BOCH GROUP



Sweden
Villeroy & Boch Gustavsberg AB
Charottevägen 15
Box 400
134 29 Gustavsberg
Phone +46 8 570 391 00
Fax +46 8 570 320 36
info@gustavsberg.com

Norway
Villeroy & Boch Norge AS
Luhrtoppen 2
Postboks 13
1471 Lørenskog
Tlf. + 47 67 97 82 50
Faks +47 67 97 16 57
info@gustavsberg.no

Estonia
Oy Gustavsberg Ab Eesti Filiaal
F. R. Faehlmanni 6
10125 Tallinn
Telefon + 372 646 0312
E-mail: info@gustavsberg.ee

Lithuania
OY Gustavsberg AB Filialas
Maironio 25-23,
10125 Tallinn
Tel.: +370 5 2460811
El.paistas: info@gustavsberg.com

Russia
Представительство Gustavsberg
127287 Москва
ул. 2-ая Хуторская д. 38А/013
Тел.: + 7 495 609 6560
Факс: + 7 495 609 6632
info.russia@gustavsberg.com

Denmark
Villeroy & Boch Danmark A/S
Villensbækvej 26-28
2605 Brøndby
Tlf + 45 36 70 80 55
Fax + 45 36 72 08 05
info@gustavsberg.dk

Suomi/Finland
Oy Gustavsberg Ab
Lauripatie 14 b
00880 Helsinki
Puh 09-32 91 88 11
Fax 09-32 91 88 50
myynti@gustavsberg.com

Latvia
Oy Gustavsberg Ab pārstāvniecība Latvijā
Kraista iela 68 A
LV - 1019 Rīga
Latvija
Tālrunis: +371 6724 5511
Fakss: +371 6724 5519
e-pasts: info.latvia@gustavsberg.com

Україна
ПРЕДСТАВИЦТВО Gustavsberg в УКРАЇНІ
01030 Київ, Україна
вул. Богдана Хмельницького,
17/52 оф. 401а
Latvija
Тел. +38 044 493 98 68
Факс +38 044 493 98 67
info.ukraine@gustavsberg.com

Russia
Представительство Gustavsberg
191036 Санкт-Петербург
ул. 9-ая Советская, 5А / 8Н
Тел.: + 7 812 326 7896
Факс: + 7 812 326 7899
info.russia@gustavsberg.com

Czech Republic / Slovakia
Villeroy & Boch Czech s.r.o.
Tukova 2319/5b
149 00 Praha 4 - Chodov
Czech Republic
Tel: +420 271 001 647
info-cz@villeroy-boch.com

Romania
SC Mondial SA
Timisoara str 149-151
305500 LUGOJ
Romania
Tel: 0040 256 356155
mondial.sales@villeroy-boch.com

Ukraine
Представництво Villeroy & Boch Gustavsberg в Україні
вул. Богдана Хмельницького 17/52а, оф. 401а,
м. Київ, 01030
тел: +38044 493 98 68
факс: +38044 493 98 67
info@gustavsberg.kiev.ua

NORDIC³

SWE MONTERINGSANVISNING NORDIC³ TERMOSTAT
GBR MOUNTING INSTRUCTIONS NORDIC³ THERMOSTAT
DEN MONTERINGSANVISNING NORDIC³ TERMOSTAT
NOR MONTERINGSANVISNING NORDIC³ TERMOSTAT
FIN NORDIC³ TERMOSTAATTIHANOJEN ASENNUSOHJE
EST NORDIC³ TERMOSTAATSEGIŠTI PAIGALDUSJUHEND
LAT UZSTĀDĪŠANAS INSTRUKCIJA NORDIC³ TERMOJAUCĒJKRĀNS
LTU TERMOSTATINIO MAIŠYTUVO NORDIC³ MONTAVIMO INSTRUKCIJA
UKR ІНСТРУКЦІЯ З МОНТАЖУ ТЕРМОСТАТИЧНОГО ЗМІШУВАЧА NORDIC³
CZE MONTÁŽNÍ NÁVOD NORDIC³ TERMOSTATICKÉ BATERIE
SVK MONTÁŽNY NÁVOD NORDIC³ TERMOSTATICKÉ BATÉRIE
ROU INSTRUCȚIUNI DE MONTARE NORDIC³ TERMOSTAT

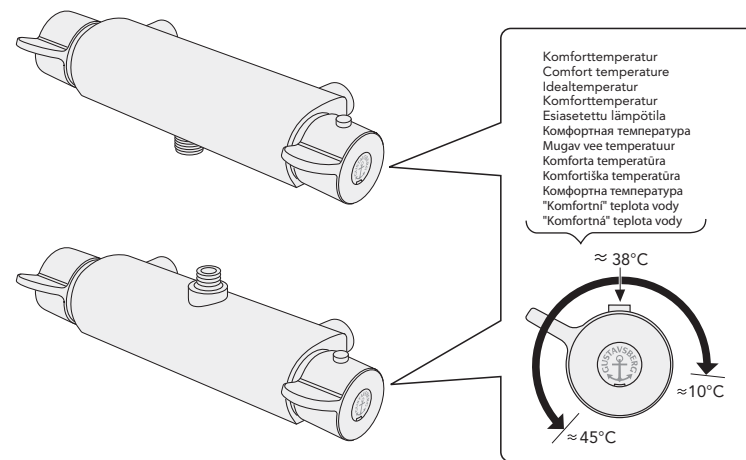

Komforttemperatur
Comfort temperature
Idealtemperatur
Etsasetettu lämpötila
Komfortna temperatura
Mugav vee temperatuur
Komforta temperatura
Komfortiška temperatura
Komfortna temperatura
"Komfortni" teplota vody
"Komfortná" teplota vody

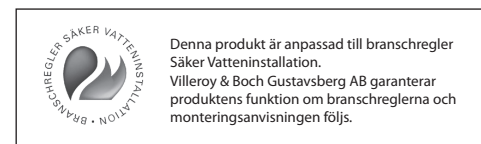
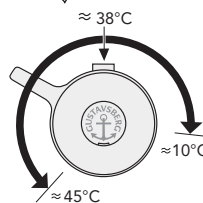

Denna produkt är anpassad till branschregler
Säker Vatteninstallation.
Villeroy & Boch Gustavsberg AB garanterar
produktens funktion om branschreglerna och
monteringsanvisningen följs.

NORDIC³ 150 c-c. 160 c-c

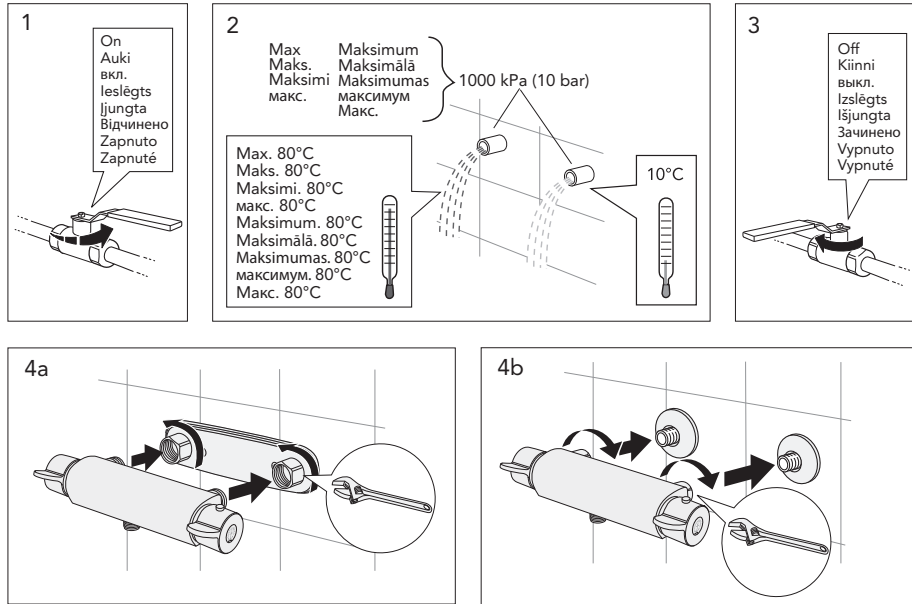

Demontera - fryspunkt
Dismount - freezing point
Fjerne fastinstillingen
Demontere-frysepunkt
Irrota jos jääytymisvaara
демонтаж- при замерзании
Eemalda - külumumisvõimalusel
Aizsāšanas sliekšnis
Išmontuoti esant užšalimo tikimybei
Демонтувати при температурі нижче 0°C
Odmontujte při mrazu
Odmontujte při mrazu

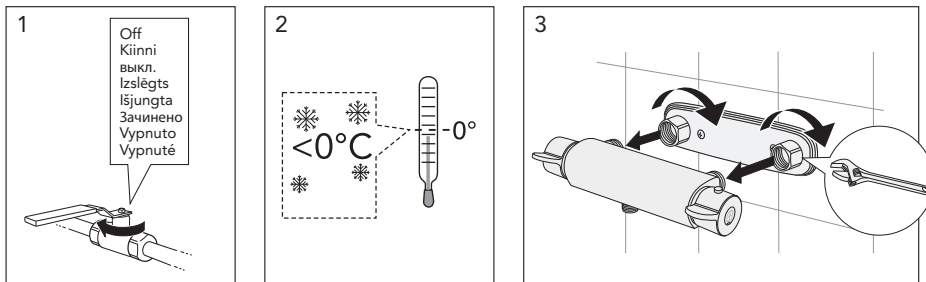

Justera temperaturen
Temp adjustment
Justere temperaturen
Justere temperaturen
Säädä lämpötilarajoinin
Настройка ограничителя температуры
Temperatuuri reguleerimine
Temperatūras regulēšana
Temperatūros reguliuotojas
Налаштування температури
Nastavení teploty
Nastavenie teploty

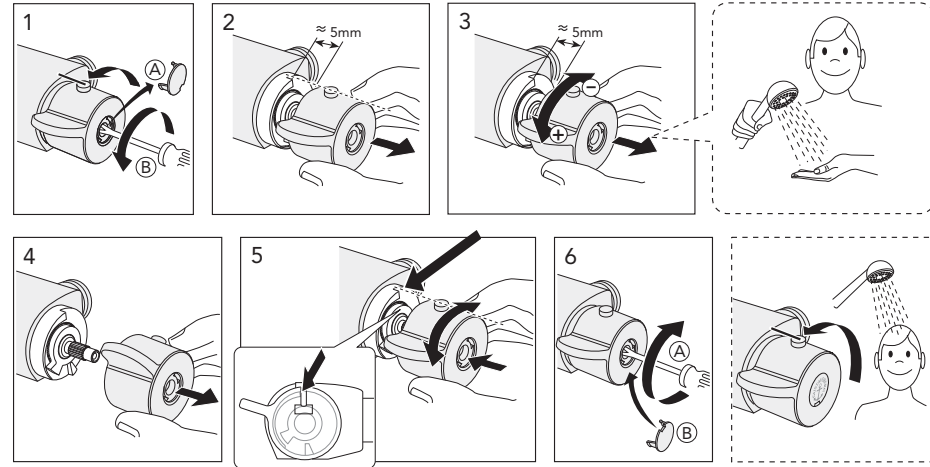
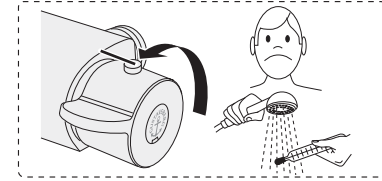

Begränsa temperaturen (Maxvärme)
Limit temperature (Max hot)
Begränse temperaturen (Max varme)
Begränse temperaturen (Maks varme)
Kuuman veden rajoittaminen (Kuuman veden rajoittaminen)
Настройка ограничителя температуры (Ограничитель горячей воды)
Temperatuuri piiramine (Reguleerimine maksimum temperatuurile)
Temperatūras ierobežošana (Maksimāli karsta)
Ribota temperatūra (Maksimāli karsta)
Лімітування температури (Максимально гаряча)
Hraníční teplota (Max horčá)
Hraníčná teplota (Max horčá)

