

Monteras ej i VVC-system.

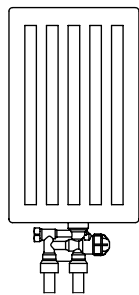

VMO/VMC

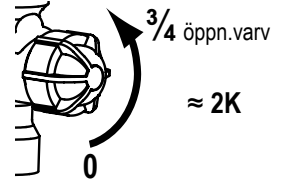
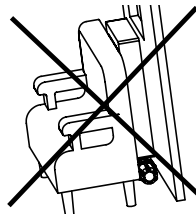
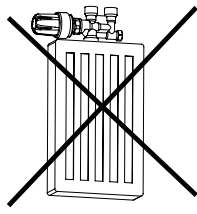
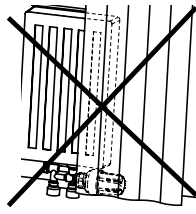

ENH



MT.



NHN

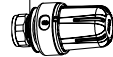

MT.Z



ENTL

Levererad som 2-rörsventil.

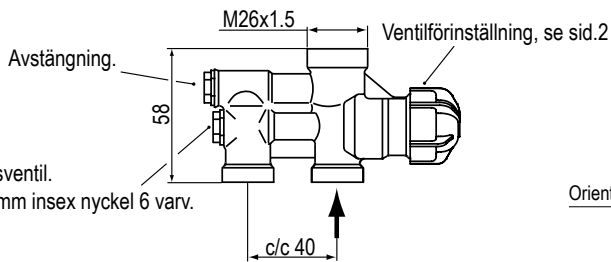

Omställning 1-2 rörsventil.

Öppna med en 2,5 mm insex nyckel 6 varv.

Montering

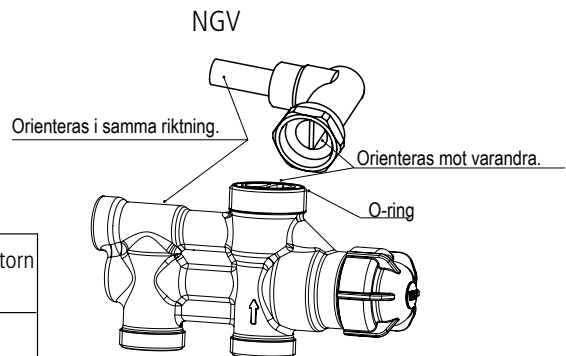
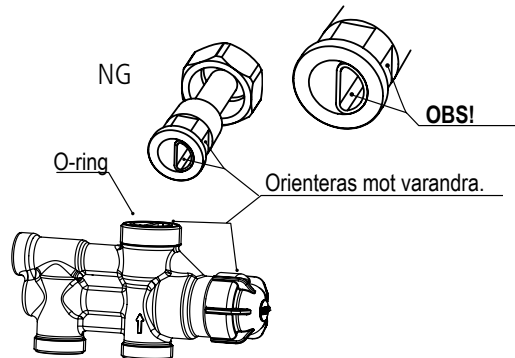

Typ	Anslutning mot rörsidan	Anslutning med NG/NGV mot radiatorn
RFA 38	M22x1.5	ISO-R 1/2

1-rörssystem

Kv_{2K}
(Ventilförinställning fullt öppen)

öppn.varv X Bypass	Kv total	Kv radiator	% radiator
0.5	0.78	0.7	90
1	0.82	0.66	81
1.5	0.85	0.65	73
2	1.05	0.63	64
2.5	1.12	0.62	55
3	1.28	0.61	45
3.5	1.42	0.57	40
4	1.60	0.53	33
4.5	1.78	0.48	27
5	1.88	0.43	22

Kv_S
(Ventilförinställning fullt öppen)

öppn.varv X Bypass	Kv total	Kv radiator	% radiator
0.5	0.84	0.77	91
1	0.89	0.76	85
1.5	0.95	0.74	77
2	1.02	0.70	69
2.5	1.12	0.68	61
3	1.23	0.64	51
3.5	1.34	0.60	45
4	1.49	0.57	38
4.5	1.65	0.52	32
5	1.80	0.48	27

Inställning bypass

1. Ta bort den blå plastpluggen.

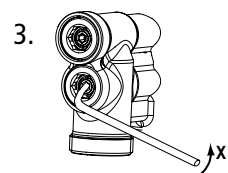
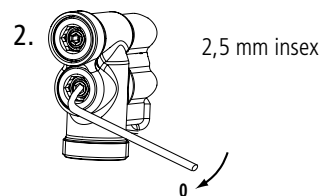

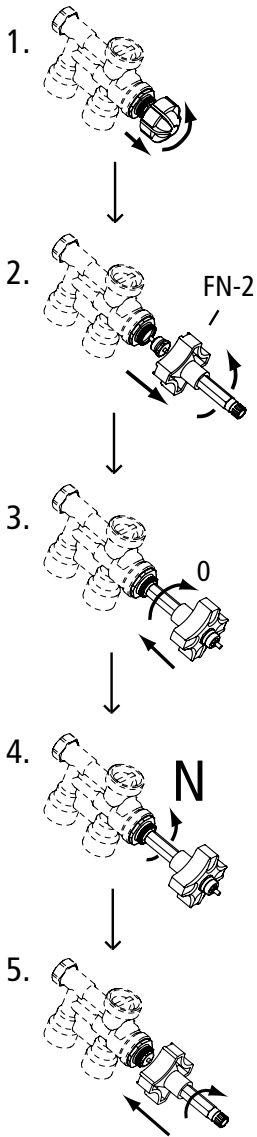

Öppn.varv

N

gäller för:

Kv_S

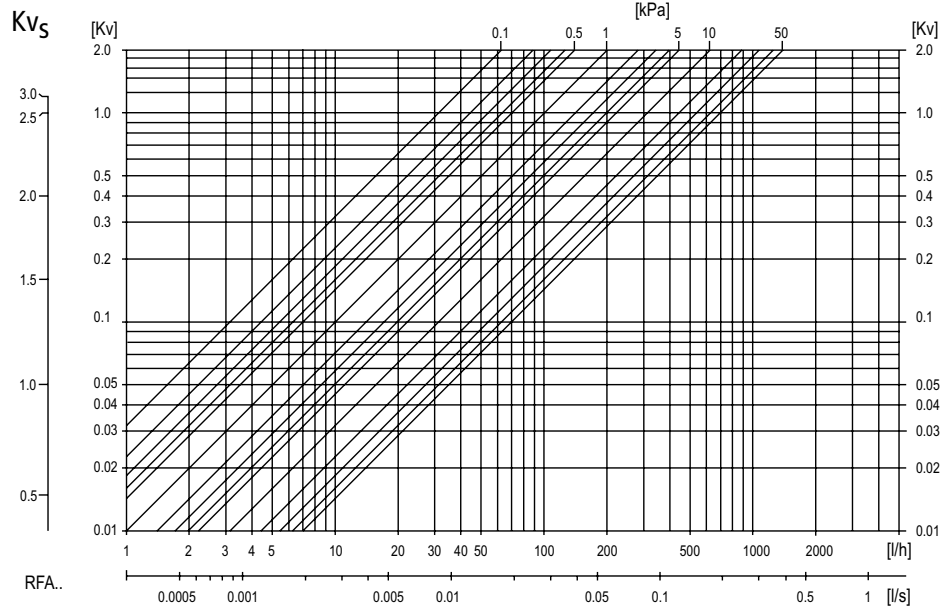

Förinställning av 2-rörssystem
kan även göras m.h.a. FV 5.

Levererad i detta utförande som 2-rörssystem.
Omställning 1-rör öppna med en 2,5 mm
insex nyckel 6 varv.

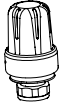
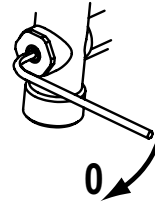

Öppn.varv

N

gäller för:

Kv_{2K}

RFA..