

CLASS

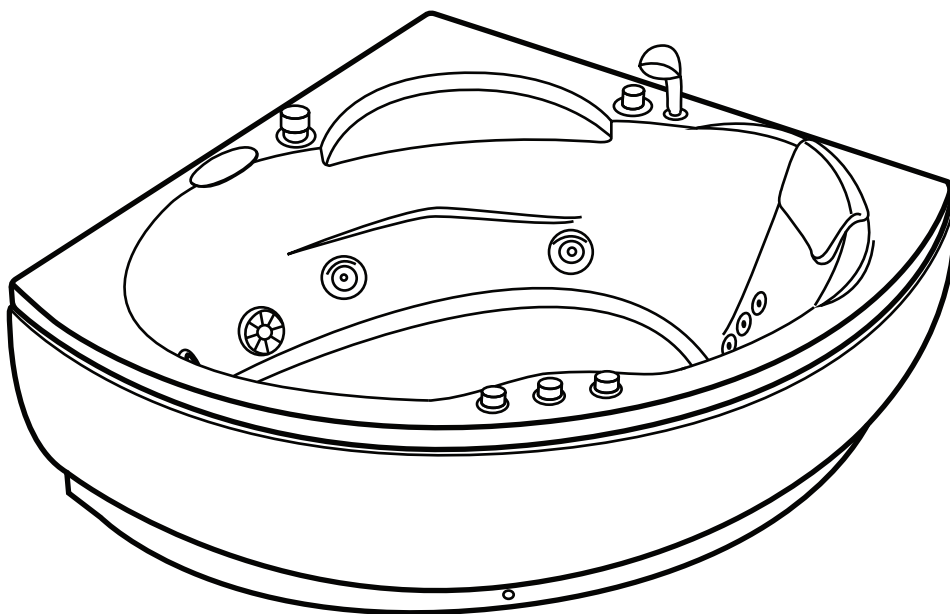

EN 60335-1:2012+A11:2014 (15)
EN 60335-2-60:2003+A1:2005+A2:2008 (15)
EN 60335-2-60:2003+A11:2010+A12:2012 (15)



bathlife
ofsweden
.com

© 2016



bathlife[®]

OF SWEDEN

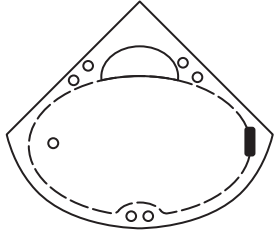

x1

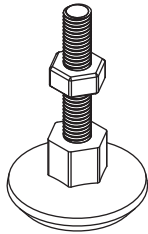

x6

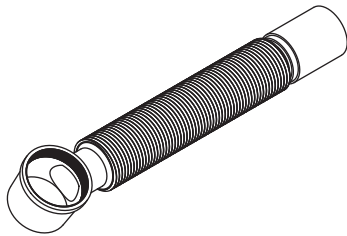

x1

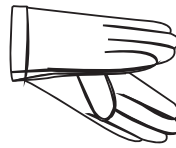
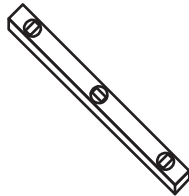
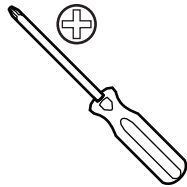



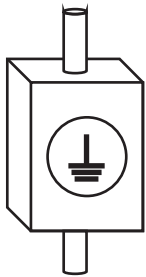
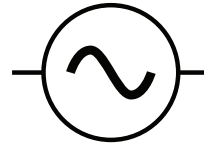

VITAL ✗ ECO ✓ PLUS ✓

230V AC

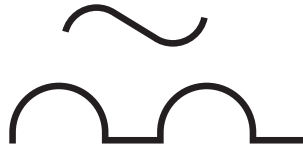

GFCI/RCD
MAX 30mA



 <p>750W</p>	 <p>1500W</p>
<p>VITAL ✗ ECO ✓ PLUS ✓</p>	<p>VITAL ✗ ECO ✗ PLUS ✓</p>

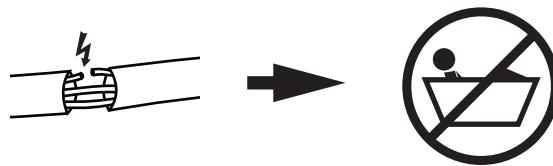
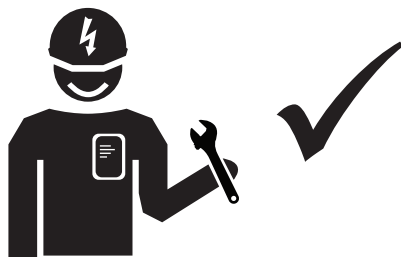



VITAL ✗ ECO ✓ PLUS ✓

$\geq 0,23$ MPa 



MAX 60°C

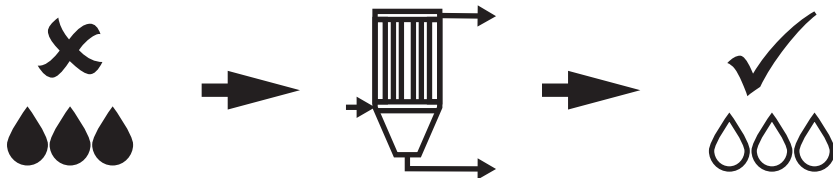
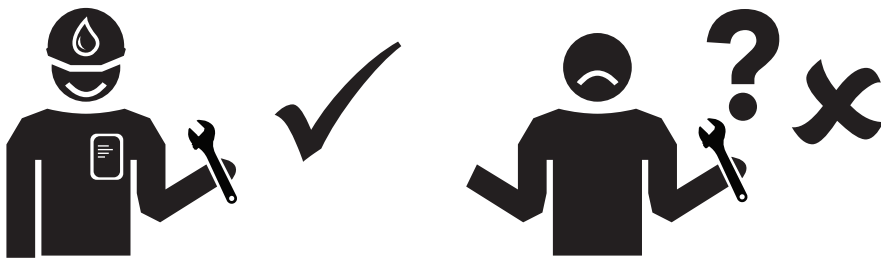
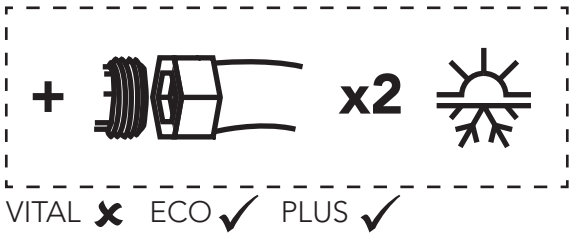

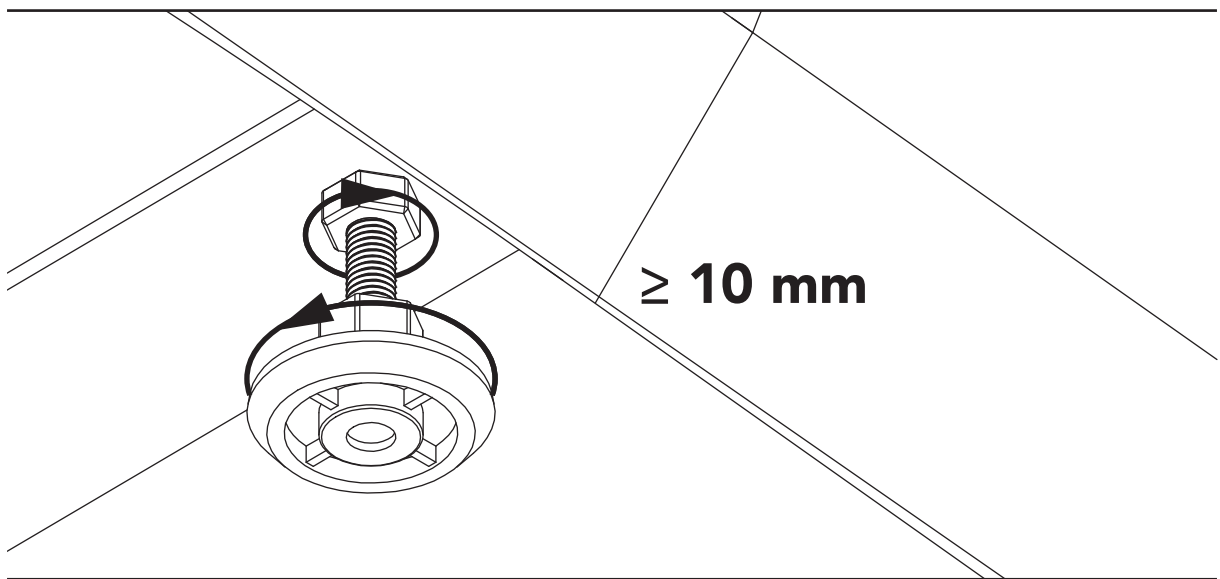
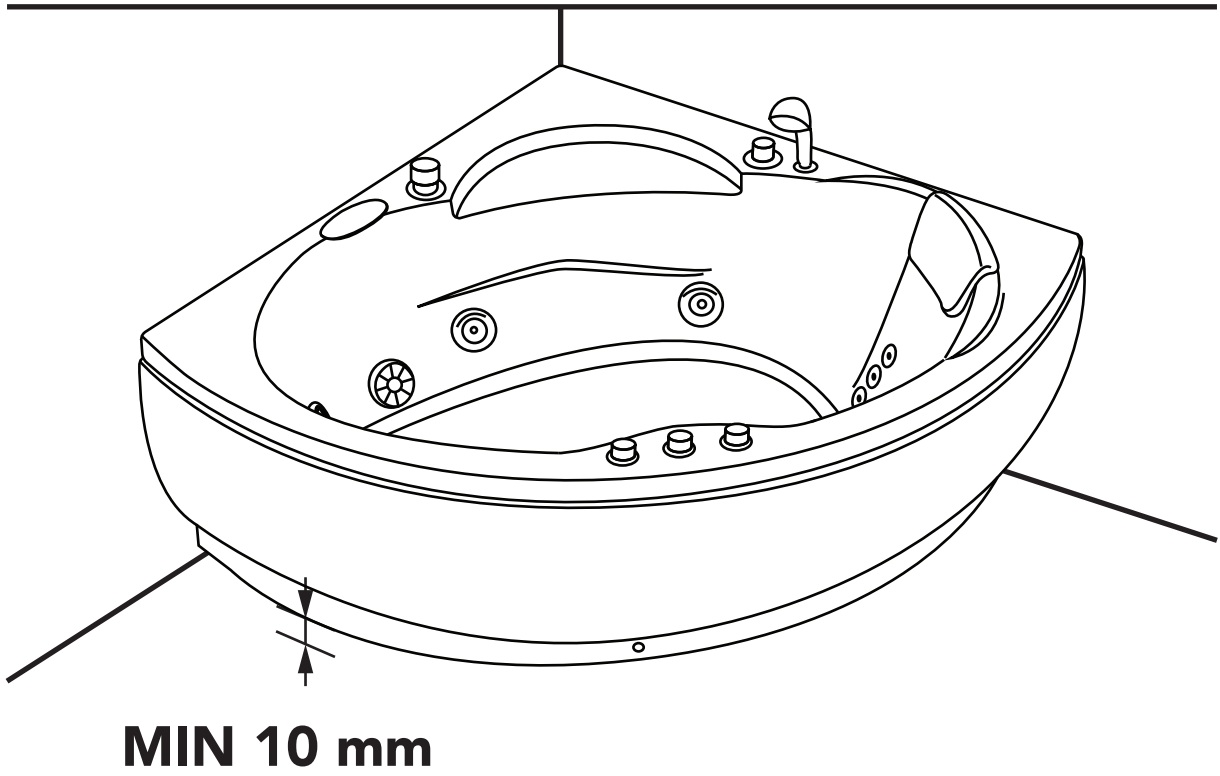
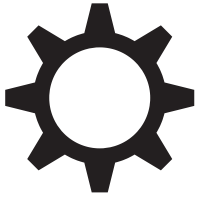

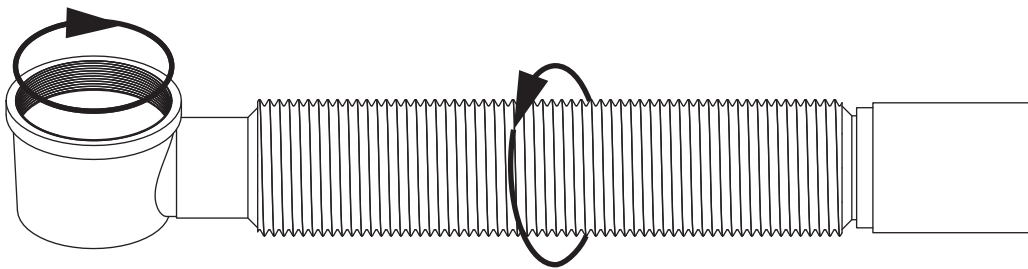
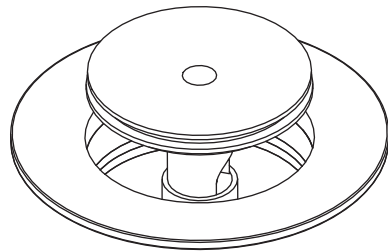
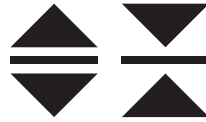
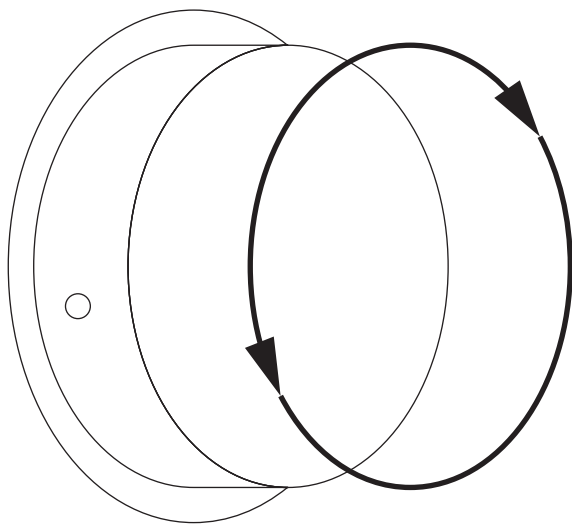
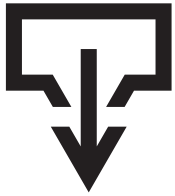

400 - 1200 mm

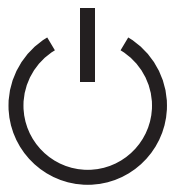

VITAL ✗ ECO ✓ PLUS ✓



SOME MODELS ONLY
ENDAST VISSA MODELLER

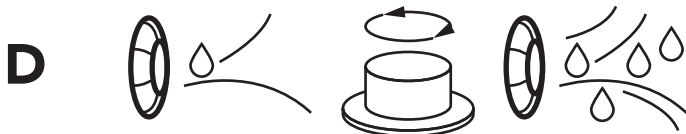

+ **AUTO ≈ 40°C**
 → / **MAX x50**

VITAL ✗ ECO ✗ PLUS ✓

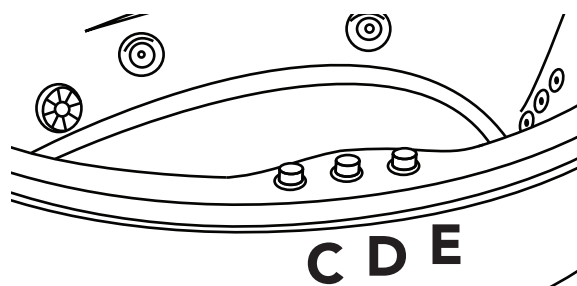
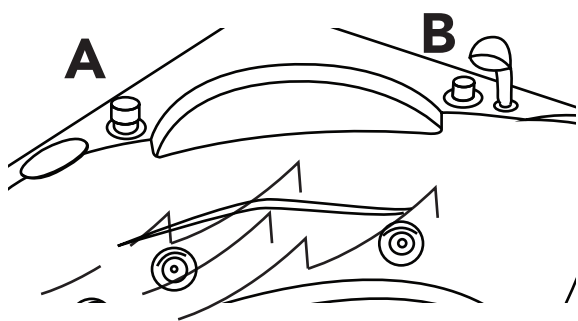



Never use chemicals with bleaching or abrasive properties.
Använd aldrig kemikalier med blekande eller slipande egenskaper.
Bruk aldri kjemikalier med blegning eller slipende egenskaper.
Brug aldrig kemikalier med blegemiddel eller slibende egenskaber.
Älä koskaan käyttää kemikaaleja valkaisevaa tai hankaavia ominaisuuksia.
Verwenden sie niemals chemikalien mit bleichmittel oder abrasiven eigenschaften.

